



Krachtig in het dagelijks gebruik



VOORDELEN

- Calcium-Calcium- Technologie
- Onderhoudsvrij
- Betrouwbaar en duurzaam
- Geschikt voor een laad spanning van 14.8 Volt
- Gevuld en geladen
- Schokbestendig
- Geïntegreerde handgreep
- Gebruiksklaar
- Voor elke type leverbaar

TOEPASSING

- Vrachtauto's
- Zwaar transport
- Bussen
- Traktoren
- Bouwmachines
- Hulp- en redding voertuigen
- etc.

VOOR IEDER TYPE!

Met de uitgebreide variëteit aan soorten van de Panther **Premium** serie met capaciteiten van **600 tot 1500 AH** De Panther **Premium** accu is van hoge kwaliteit voor de beste prijs. Met zekerheid heeft u met de Panther **Premium** de juiste accu voor uw toepassing.



**PREMIUM CLASS
AKKUMULATOR**

Ca-Ca
cium cium
Technologie

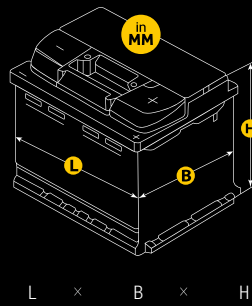

ARTIKELNUMMER	BESCHRIJVING	SPANNING VOLT	CAPACITEIT AH	STARTVERMOGEN A/EN	L	B	H	SCHAKELING	TYPE POOL	BODEMBEVESTIGING	GEWICHT KG
SB.6002633	6002633	12	100	600	413	175	220	0	1	B00	26.3
SB.6052533	6052533	12	105	760	413	175	220	0	1	B00	22.9
SB.6052733	6052733	12	105	680	349	175	235	1	1	B00	26.7
SB.6052833	6052833	12	105	680	349	175	235	0	1	B00	28.6
SB.6104033	6104033	12	110	760	514	175	210	3	1	B03	32.3
SB.6100433	6100433	12	110	680	347	173	234	0	1	B03	28.6
SB.6203833	6203833	12	120	680	510	175	235	4	1	B03	35.1
SB.6204533	6204533	12	120	680	514	189	223	3	1	B00	33.6
SB.6251133	6251133	12	125	620	349	175	290	0	1	B00	34.9
SB.6251333	6251333	12	125	620	349	175	290	1	1	B00	31.2
SB.6252333	6252333	12	125	800	286	269	230	2	1	B00	30.3
SB.6301433	6301433	12	130	680	514	218	208	3	1	B00	26.0
SB.6354233	6354233	12	135	680	360	253	240	0	1	B11	27.5
SB.6354533	6354533	12	135	680	514	189	223	3	1	B00	35.2
SB.6355233	6355233	12	135	1000	514	175	210	3	1	B03	35.6
SB.6403533	6403533	12	140	760	514	189	223	3	1	B00	35.7
SB.6403633	6403633	12	140	760	514	178	223	3	1	B03 innen	37.4
SB.6431733	6431733	12	143	900	513	223	225	3	1	B00	39.7
SB.6433333	6433333	12	143	950	514	218	210	3	1	B03	39.9
SB.6541133	6541133	12	154	1300	513	189	223	3	1	B00	40.0
SB.6551333	6551333	12	155	900	513	223	225	3	1	B00	41.0
SB.6704333	6704333	12	170	1000	513	223	223	3	1	B00	44.0
SB.6741133	6741133	12	174	1500	513	223	223	3	1	B00	47.0
SB.6801733	6801733	12	180	1200	513	223	223	3	1	B03	40.0
SB.6801933	6801933	12	180	1000	513	223	223	3	1	B03	40.0
SB.6803233	6803233	12	180	1000	513	223	223	3	1	B00	43.9
SB.6808933	6808933	12	180	1100	513	223	223	4	1	B03	45.0
SB.7003833	7003833	12	200	1050	518	274	242	3	1	B00	53.6
SB.7251233	7251233	12	225	1150	518	274	242	3	1	B00	55.6





Bodembevestiging B00



Type pool 1

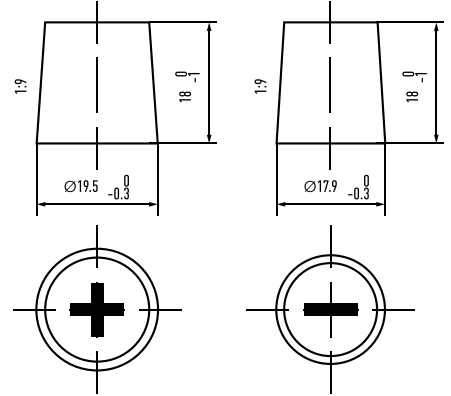

Bodembevestiging B03

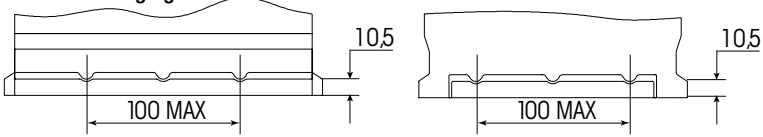

Bodembevestiging B11

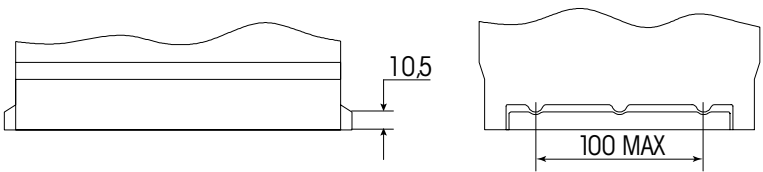

Positie +pool 0 (rechts)

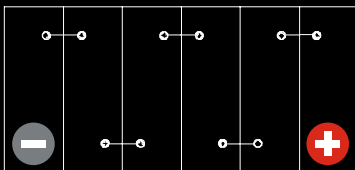

Positie +pool 1 (links)

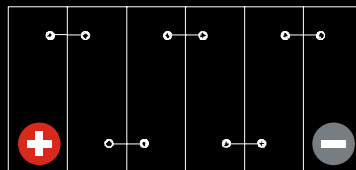

Positie +pool 2 (rechts)

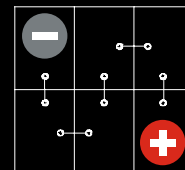

Positie +pool 3 (links)

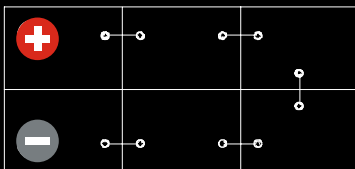

Positie +pool 4 (rechts)

